

脱离电池运行的 TPS7B81-Q1 150mA、超低 I_Q (3 μ A) 低压降稳压器

1 特性

- 符合面向汽车应用的 AEC-Q100 标准：
 - 温度等级 1: -40°C 至 125°C, T_A
- 器件结温范围：-40°C 至 150°C
- 3V 至 40V 宽 V_{IN} 输入电压范围，瞬态电压高达 45V
- 最大输出电流：150mA
- 低静态电流 I_Q ：
 - EN = 低电平时典型值为 300nA (关断模式)
 - 轻负载时典型值为 2.7 μ A
 - 轻负载时最大值为 4.5 μ A
- 线路、负载和温度范围内的输出电压精度为 1.5%
- 最大压降电压：对于固定 5V 输出电压版本，150mA 负载电流下为 540mV
- 与低 ESR (0.001 Ω 至 5 Ω) 陶瓷输出稳定电容器 (1 μ F 至 200 μ F) 搭配使用时可保持稳定
- 5V、3.3V 和 2.5V 固定输出电压
- 集成故障保护：
 - 热关断
 - 短路和过流保护
- 封装：
 - DGN (8 引脚 HVSSOP), $R_{\theta JA} = 63.9^\circ\text{C/W}$
 - DRV (6 引脚 WSON), $R_{\theta JA} = 72.8^\circ\text{C/W}$
 - KVU (5 引脚 TO-252), $R_{\theta JA} = 38.8^\circ\text{C/W}$ 添加了项目符号

2 应用

- 汽车音响主机
- 前照灯
- 电池管理系统 (BMS)
- 逆变器和电机控制

3 说明

在汽车电池连接应用中，低静态电流 (I_Q) 对于省电和延长电池寿命而言非常重要。始终开启的系统必须在扩展温度范围内实现超低 I_Q ，以便在车辆点火开关关闭时也能实现持久运行。

TPS7B81-Q1 是一款低压降 (LDO) 线性稳压器，专为高达 40V V_{IN} 的这些领域而设计。此器件在轻负载时的典型静态电流仅为 2.7 μ A，是用于为待机系统中的微控制器以及控制器局域网和本地互连网络 (CAN/LIN) 收发器供电的最佳解决方案。

此器件具有集成式短路和过流保护。此器件可在 -40°C 至 +125°C 的环境温度下运行，结温范围为 -40°C 至 +150°C。此外，此器件提供多种具有不同尺寸和热导率的封装选项。小型 WSON 封装有助于实现最紧凑的 PCB 设计，即使整个器件散热较多，TO-252 封装也能让器件实现持久运行。这些特性使得此器件非常适合用作各种电池连接汽车这些领域。

器件信息(1)

器件型号	封装	封装尺寸 (标称值)
TPS7B81-Q1	HVSSOP (8)	3.00mm x 3.00mm
	WSON (6)	2.00mm x 2.00mm
	TO-252 (5)	6.10mm x 6.60mm

(1) 如需了解所有可用封装，请参阅数据表末尾的可订购产品附录。

典型应用原理图

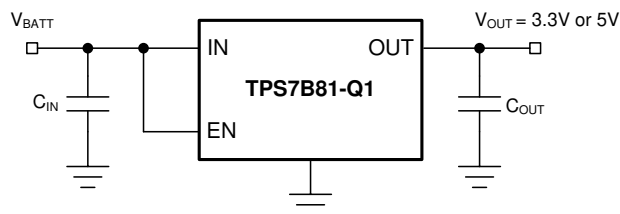

目录

1	特性	1	7.4	Device Functional Modes.....	12
2	应用	1	8	Application and Implementation	13
3	说明	1	8.1	Application Information.....	13
4	修订历史记录	2	8.2	Typical Application	17
5	Pin Configuration and Functions	3	9	Power Supply Recommendations	18
6	Specifications	5	10	Layout	19
6.1	Absolute Maximum Ratings	5	10.1	Layout Guidelines	19
6.2	ESD Ratings.....	5	10.2	Layout Example	19
6.3	Recommended Operating Conditions.....	5	11	器件和文档支持	20
6.4	Thermal Information	5	11.1	接收文档更新通知	20
6.5	Electrical Characteristics.....	6	11.2	支持资源.....	20
6.6	Typical Characteristics.....	7	11.3	商标.....	20
7	Detailed Description	11	11.4	静电放电警告.....	20
7.1	Overview	11	11.5	Glossary	20
7.2	Functional Block Diagram	11	12	机械、封装和可订购信息.....	20
7.3	Feature Description.....	11			

4 修订历史记录

注：之前版本的页码可能与当前版本有所不同。

Changes from Revision B (August 2019) to Revision C Page

• 已更改 将 KVU 封装从“预览”更改为“生产数据”	1
• 已更改 应用 部分	1

Changes from Revision A (June 2019) to Revision B Page

• 已更改 将 DGN 封装从“预览”更改为“生产数据”	1
• 已更改 将 525mV 更改为 540mV (在最大压降电压 特性 项目符号)	1
• 已添加 $R_{\theta JA}$ versus Cu Area for the HVSSOP (DGN) Package through ψ_{JB} versus Cu Area for the TO-252 (KVU) Package figures to Power Dissipation section	15
• Deleted values from capacitors C_{IN} and C_{OUT} in 图 31	17

Changes from Original (May 2019) to Revision A Page

• 已更改 将“预告信息”更改为“生产数据”	1
------------------------------	----------

5 Pin Configuration and Functions

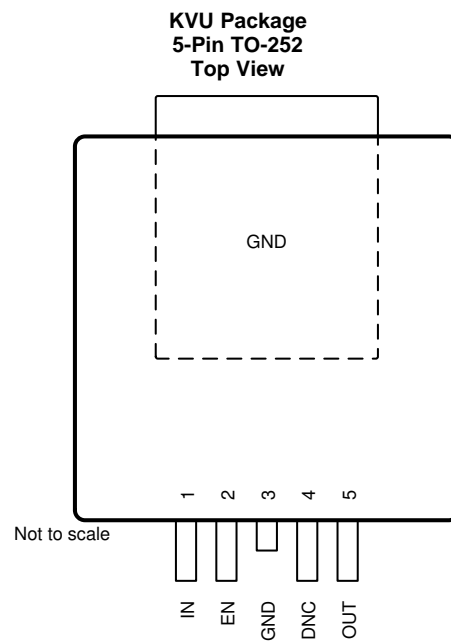
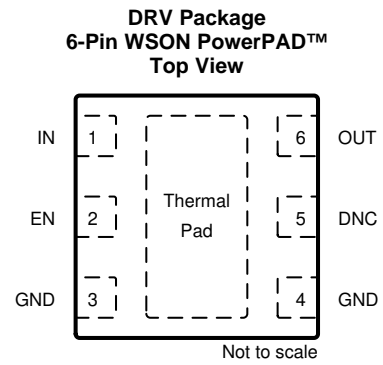
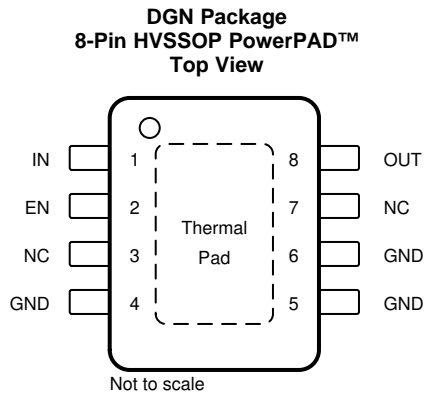

Pin Functions

NAME	PIN			I/O	DESCRIPTION
	NO.				
	DGN	DRV	KVU		
DNC	—	5	4	—	Do not connect to a biased voltage. Tie this pin to ground or leave floating.
EN	2	2	2	I	Enable input pin. Drive EN greater than V_{IH} to turn on the regulator. Drive EN less than V_{IL} to put the low-dropout (LDO) into shutdown mode.
GND	4, 5, 6	3,4	3, TAB	—	Ground reference
IN	1	1	1	I	Input power-supply pin. For best transient response and to minimize input impedance, use the recommended value or larger ceramic capacitor from IN to ground as listed in the Recommended Operating Conditions table and the Input Capacitor section. Place the input capacitor as close to the output of the device as possible.
NC	3, 7	—	—	—	Not internally connected
OUT	8	6	5	O	Regulated output voltage pin. A capacitor is required from OUT to ground for stability. For best transient response, use the nominal recommended value or larger ceramic capacitor from OUT to ground; see the Recommended Operating Conditions table and the Output Capacitor section. Place the output capacitor as close to output of the device as possible.
Thermal pad				—	Connect the thermal pad to a large-area GND plane for improved thermal performance.

6 Specifications

6.1 Absolute Maximum Ratings

over operating ambient temperature range (unless otherwise noted)⁽¹⁾⁽²⁾

		MIN	MAX	UNIT
V _{IN}	Unregulated input ⁽³⁾	-0.3	45	V
V _{EN}	Enable input ⁽³⁾	-0.3	V _{IN}	V
V _{OUT}	Regulated output	-0.3	7	V
T _J	Junction temperature range	-40	150	°C
T _{stg}	Storage temperature range	-40	150	°C

- (1) Stresses beyond those listed under *Absolute Maximum Ratings* may cause permanent damage to the device. These are stress ratings only, which do not imply functional operation of the device at these or any other conditions beyond those indicated under *Recommended Operating Conditions*. Exposure to absolute-maximum-rated conditions for extended periods may affect device reliability.
- (2) All voltage values are with respect to GND.
- (3) Absolute maximum voltage, can withstand 45 V for 200 ms.

6.2 ESD Ratings

			VALUE	UNIT	
V _(ESD)	Electrostatic discharge	Human-body model (HBM), per AEC Q100-002 ⁽¹⁾	±2000	V	
		Charged-device model (CDM), per AEC Q100-011	Corner pins		±750
			Other pins		±500

- (1) AEC Q100-002 indicates that HBM stressing shall be in accordance with the ANSI/ESDA/JEDEC JS-001 specification.

6.3 Recommended Operating Conditions

over operating ambient temperature range (unless otherwise noted)

		MIN	MAX	UNIT
V _{IN}	Unregulated input voltage	3	40	V
V _{EN}	Enable input voltage	0	V _{IN}	V
C _{OUT}	Output capacitor requirements ⁽¹⁾	1	200	μF
ESR	Output capacitor ESR requirements ⁽²⁾	0.001	5	Ω
T _A	Ambient temperature range	-40	125	°C
T _J	Junction temperature range	-40	150	°C

- (1) The output capacitance range specified in the table is the effective value.
- (2) Relevant ESR value at f = 10 kHz

6.4 Thermal Information

THERMAL METRIC ⁽¹⁾		TPS7B81-Q1			UNIT
		DGN (HVSSOP)	DRV (WSON)	KVU (TO-252)	
		8 PINS	6 PINS	5 PINS	
R _{θJA}	Junction-to-ambient thermal resistance	63.9	72.8	31.1	°C/W
R _{θJC(top)}	Junction-to-case (top) thermal resistance	50.2	85.8	39.9	°C/W
R _{θJB}	Junction-to-board thermal resistance	22.6	37.4	9.9	°C/W
ψ _{JT}	Junction-to-top characterization parameter	1.8	2.7	4.2	°C/W
ψ _{JB}	Junction-to-board characterization parameter	22.3	37.3	9.9	°C/W
R _{θJC(bot)}	Junction-to-case (bottom) thermal resistance	12.1	13.8	2.8	°C/W

- (1) For more information about traditional and new thermal metrics, see the [Semiconductor and IC Package Thermal Metrics application report](#).

6.5 Electrical Characteristics

over operating ambient temperature range, $T_J = -40^\circ\text{C}$ to $+150^\circ\text{C}$, $V_{IN} = 14\text{ V}$, and $10\text{-}\mu\text{F}$ ceramic output capacitor (unless otherwise noted)

PARAMETER		TEST CONDITIONS		MIN	TYP	MAX	UNIT
SUPPLY VOLTAGE AND CURRENT (IN)							
V_{IN}	Input voltage			$V_{OUT(Nom)} + V_{(Dropout)}$		40	V
$I_{(SD)}$	Shutdown current	EN = 0 V		0.3		1	μA
$I_{(Q)}$	Quiescent current	$V_{IN} = 6\text{ V to }40\text{ V}$, EN $\geq 2\text{ V}$, $I_{OUT} = 0\text{ mA}$		1.9		3.5	μA
		$V_{IN} = 6\text{ V to }40\text{ V}$, EN $\geq 2\text{ V}$, $I_{OUT} = 0.2\text{ mA}$	DGN package	2.7		6.5	
			DRV and KVU packages	2.7		4.5	
$V_{(IN, UVLO)}$	V_{IN} undervoltage detection	Ramp V_{IN} down until the output turns off				2.7	V
		Hysteresis				200	mV
ENABLE INPUT (EN)							
V_{IL}	Logic-input low level					0.7	V
V_{IH}	Logic-input high level			2			V
I_{EN}	Enable current				10		nA
REGULATED OUTPUT (OUT)							
V_{OUT}	Regulated output	$V_{IN} = V_{OUT} + V_{(Dropout)}$ to 40 V, $I_{OUT} = 1\text{ mA to }150\text{ mA}$		-1.5%		1.5%	
$V_{(Line-Reg)}$	Line regulation	$V_{IN} = 6\text{ V to }40\text{ V}$, $I_{OUT} = 10\text{ mA}$				10	mV
$V_{(Load-Reg)}$	Load regulation	$V_{IN} = 14\text{ V}$, $I_{OUT} = 1\text{ mA to }150\text{ mA}$		DGN package		20	mV
				DRV and KVU packages		10	
$V_{(Dropout)}$	Dropout voltage	$V_{OUT} = 5\text{ V}$	$I_{OUT} = 150\text{ mA}$	DGN package	270	540	mV
				DRV and KVU packages	325	585	
		$I_{OUT} = 100\text{ mA}$	DGN package	180	350		
			DRV and KVU packages	200	390		
		$V_{OUT} = 3.3\text{ V}$	$I_{OUT} = 150\text{ mA}$	DGN package		650	
				DRV and KVU packages	345	675	
$I_{OUT} = 100\text{ mA}$	$V_{OUT} = 2.5\text{ V}$, DGN package			750			
				500			
I_{OUT}	Output current	V_{OUT} in regulation, $V_{IN} = 7\text{ V}$ for the fixed 5-V option, $V_{IN} = 5.8\text{ V}$ for the fixed 3.3-V option		0		150	mA
$I_{(CL)}$	Output current limit	V_{OUT} short to $90\% \times V_{OUT}$		180	510	690	mA
PSRR	Power-supply ripple rejection	$V_{(Ripple)} = 0.5\text{ V}_{PP}$, $I_{OUT} = 10\text{ mA}$, frequency = 100 Hz, $C_{OUT} = 2.2\text{ }\mu\text{F}$			60		dB
OPERATING TEMPERATURE RANGE							
$T_{(SD)}$	Junction shutdown temperature				175		$^\circ\text{C}$
$T_{(HYST)}$	Hysteresis of thermal shutdown				20		$^\circ\text{C}$

6.6 Typical Characteristics

at $T_J = -40^{\circ}\text{C}$ to $+150^{\circ}\text{C}$, $V_{IN} = 14\text{ V}$, and $V_{EN} \geq 2\text{ V}$ (unless otherwise noted)



图 1. Shutdown Current vs Ambient Temperature



图 2. Quiescent Current vs Ambient Temperature

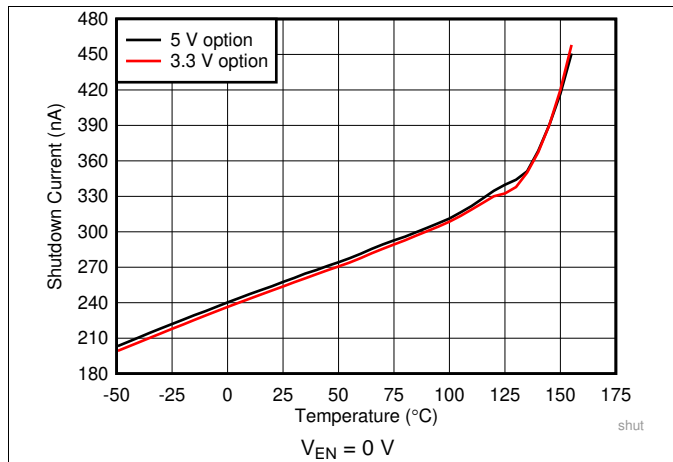

图 3. Quiescent Current vs Ambient Temperature

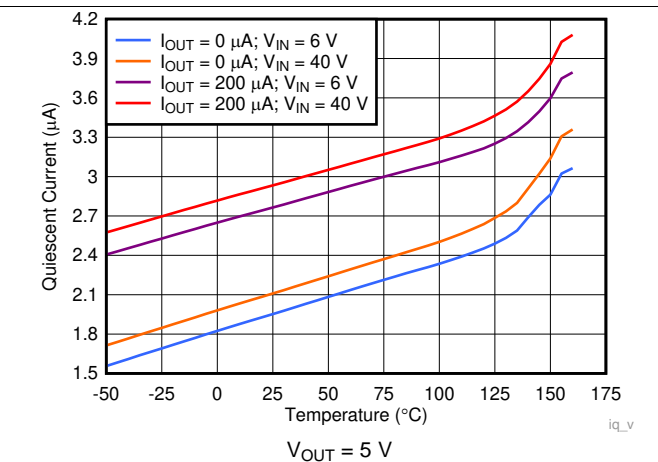

图 4. Dropout Voltage vs Output Current

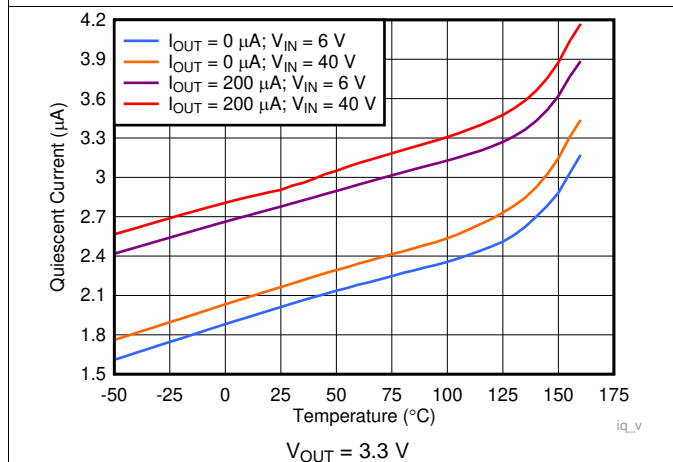

图 5. Dropout Voltage vs Output Current

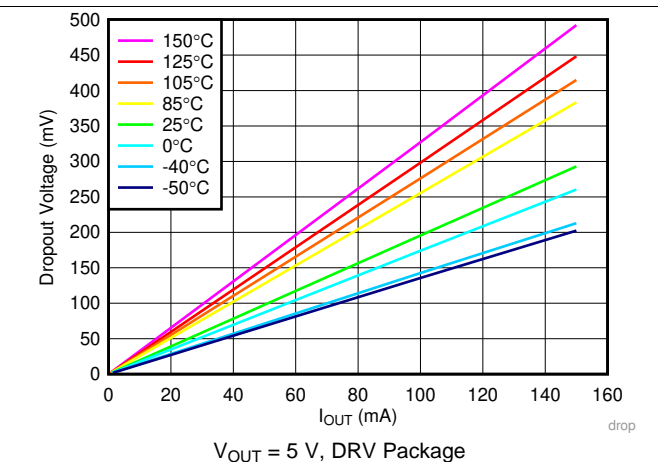

图 6. Dropout Voltage vs Ambient Temperature

Typical Characteristics (接下页)

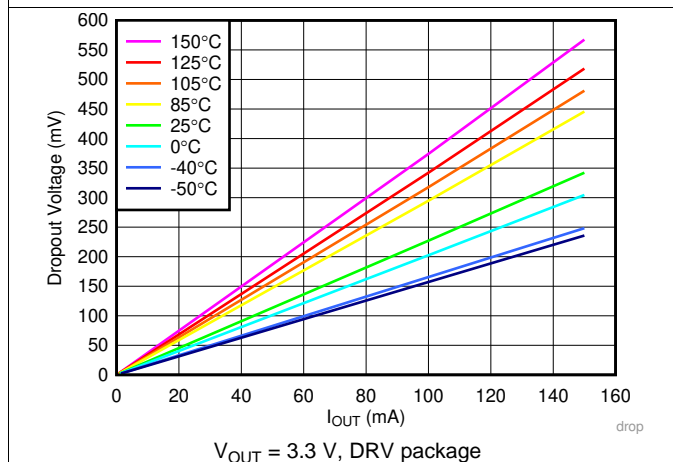
at $T_J = -40^{\circ}\text{C}$ to $+150^{\circ}\text{C}$, $V_{IN} = 14\text{ V}$, and $V_{EN} \geq 2\text{ V}$ (unless otherwise noted)

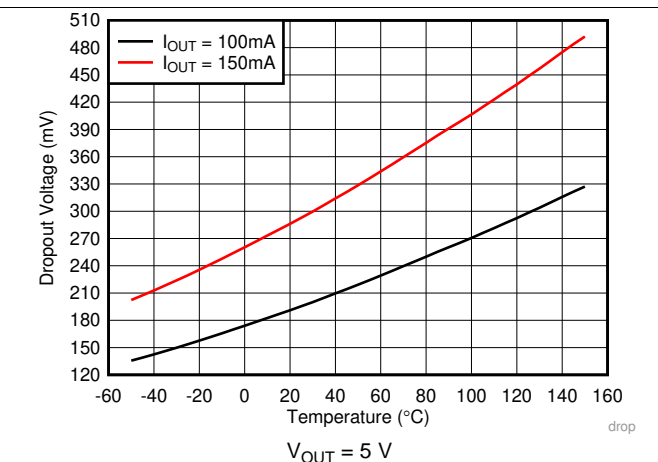

图 7. Dropout Voltage vs Ambient Temperature



图 8. Output Voltage vs Ambient Temperature

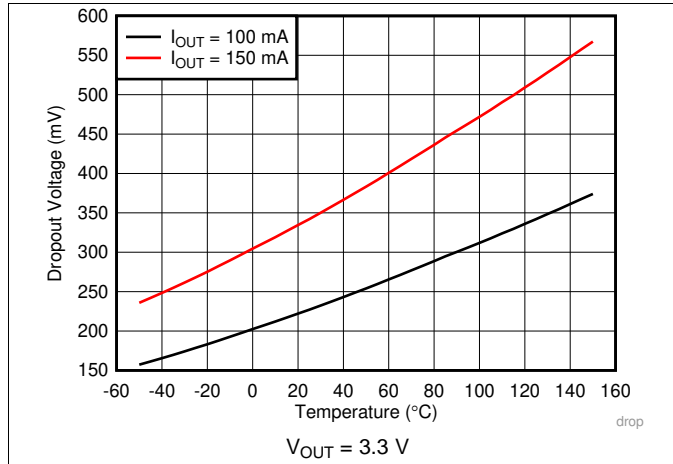

图 9. Output Voltage vs Ambient Temperature

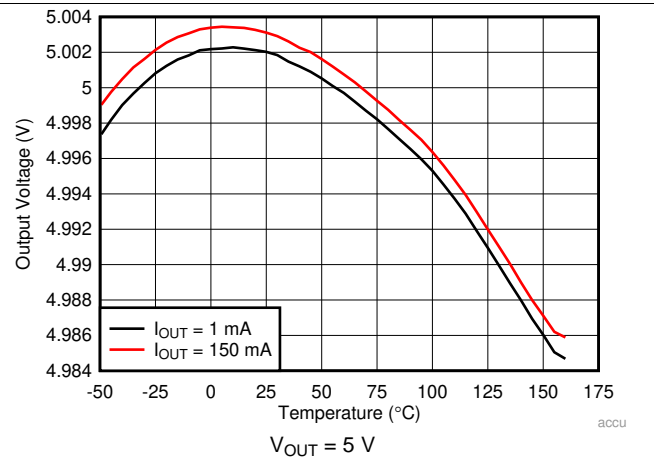

图 10. Temperature Drift Histogram (-40°C to +25°C)

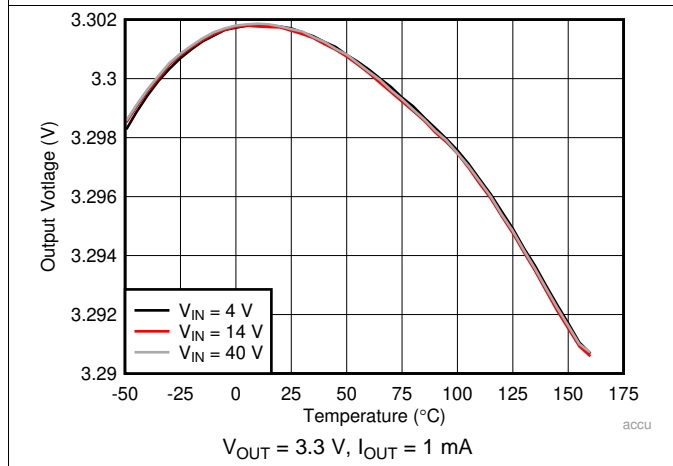

图 11. Temperature Drift Histogram (25°C to 150°C)

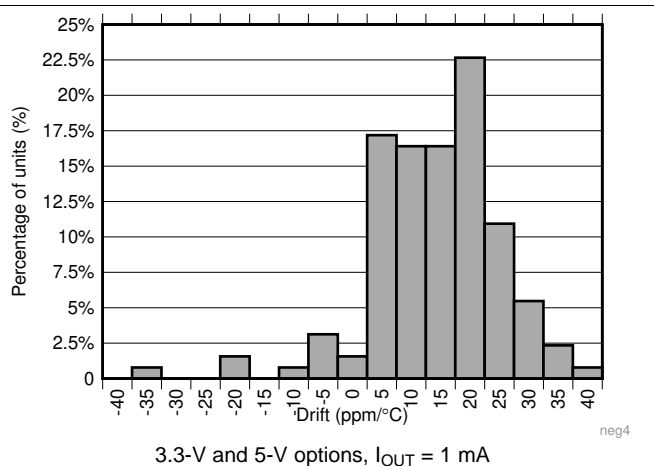

图 12. Output Voltage vs Input Voltage

Typical Characteristics (接下页)

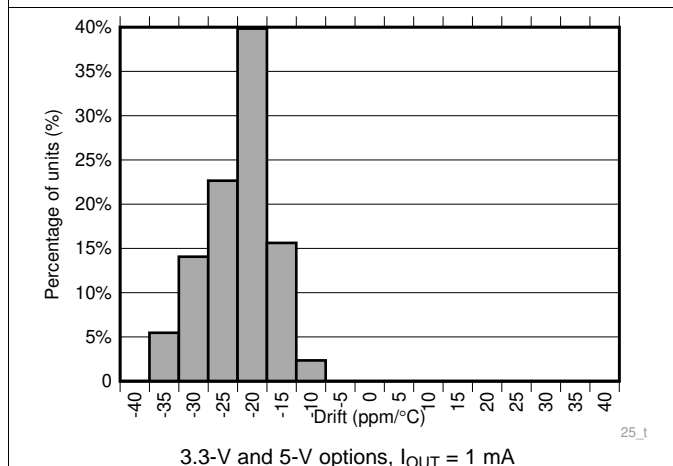
at $T_J = -40^{\circ}\text{C}$ to $+150^{\circ}\text{C}$, $V_{IN} = 14\text{ V}$, and $V_{EN} \geq 2\text{ V}$ (unless otherwise noted)

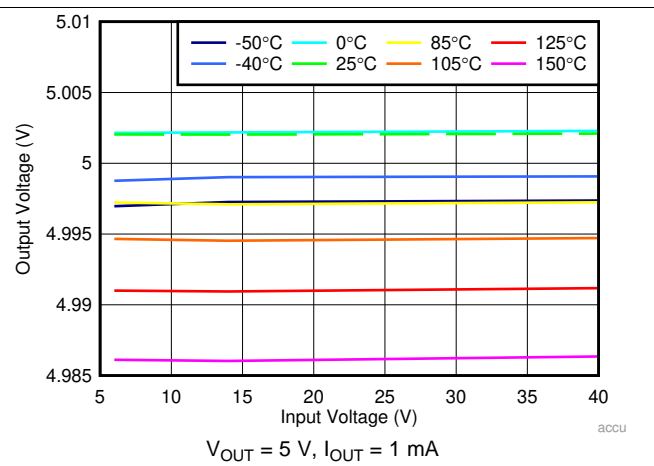

图 13. Output Voltage vs Input Voltage



图 14. Output Current Limit vs Ambient Temperature

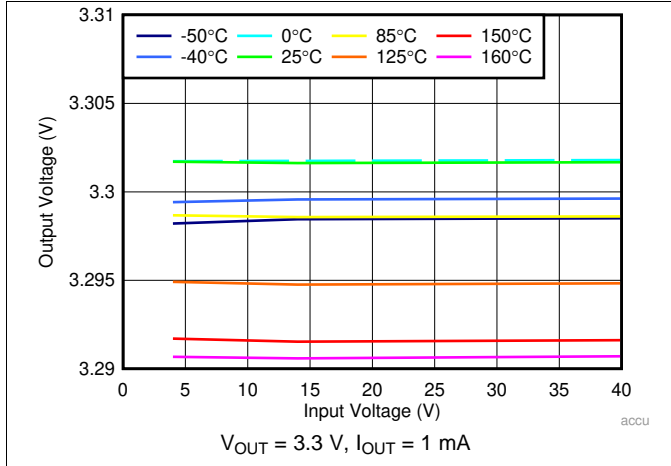

图 15. Enable Voltage vs Ambient Temperature

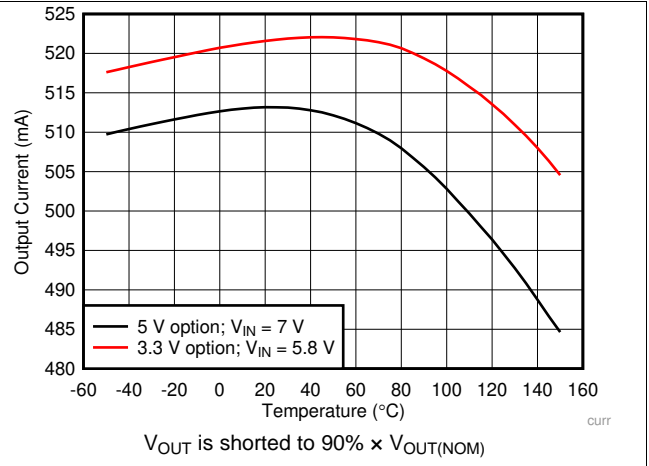

图 16. Enable Current vs Ambient Temperature

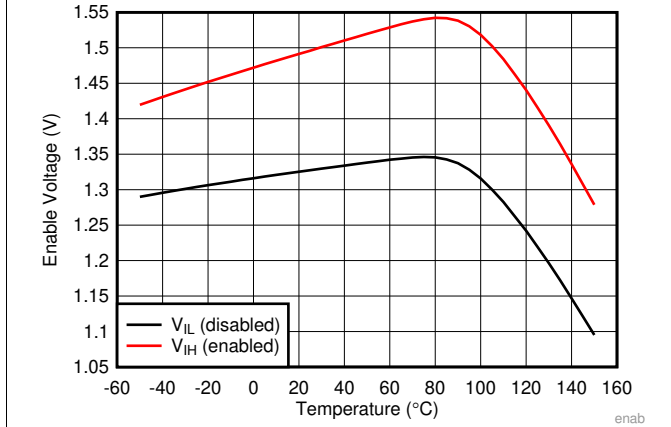

图 17. UVLO vs Ambient Temperature

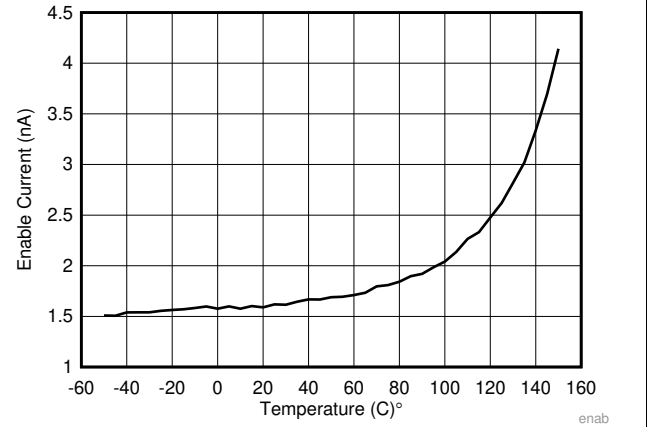

图 18. Startup with enable

Typical Characteristics (接下页)

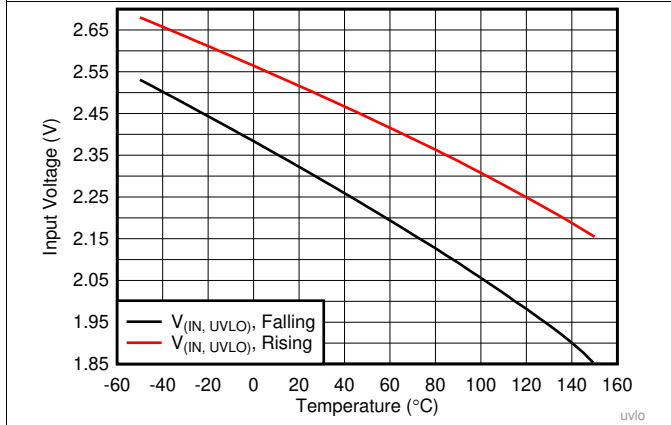
at $T_J = -40^{\circ}\text{C}$ to $+150^{\circ}\text{C}$, $V_{IN} = 14\text{ V}$, and $V_{EN} \geq 2\text{ V}$ (unless otherwise noted)

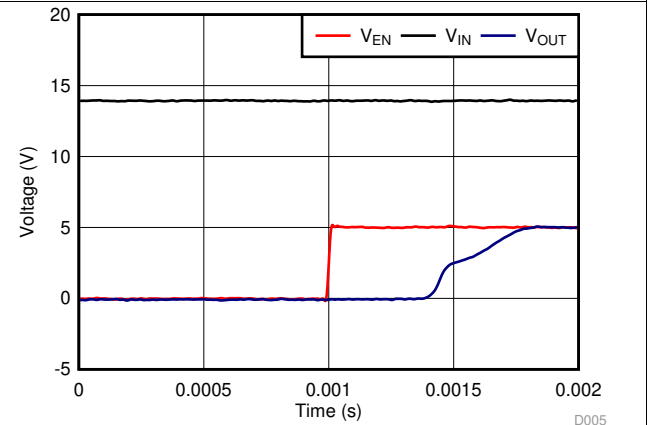

图 19. Line Transient



图 20. Load Transient

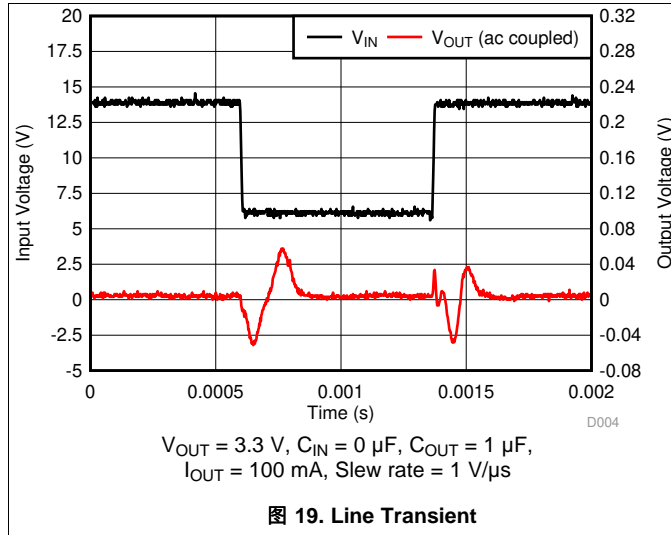

图 21. PSRR vs Frequency

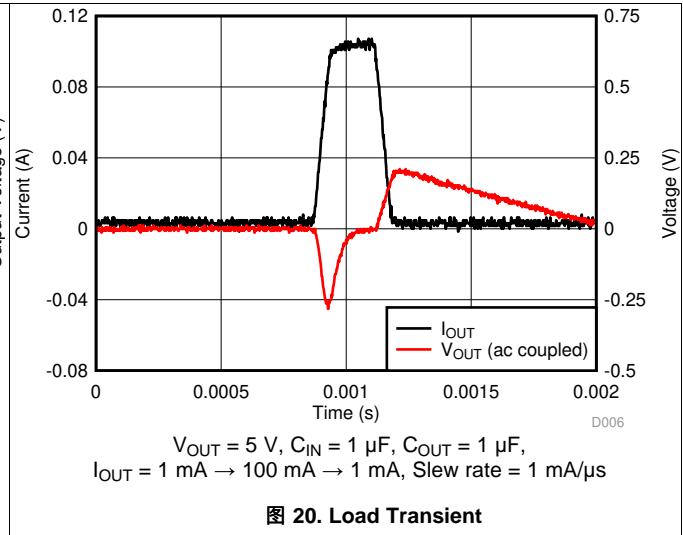

图 22. PSRR vs Frequency

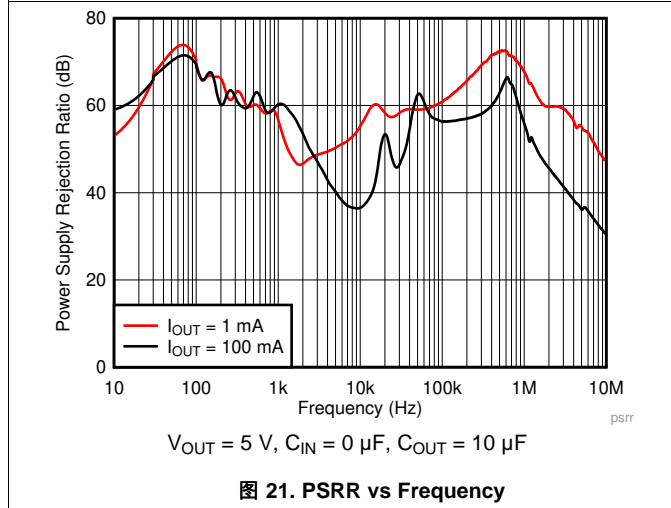

图 23. Noise vs Frequency

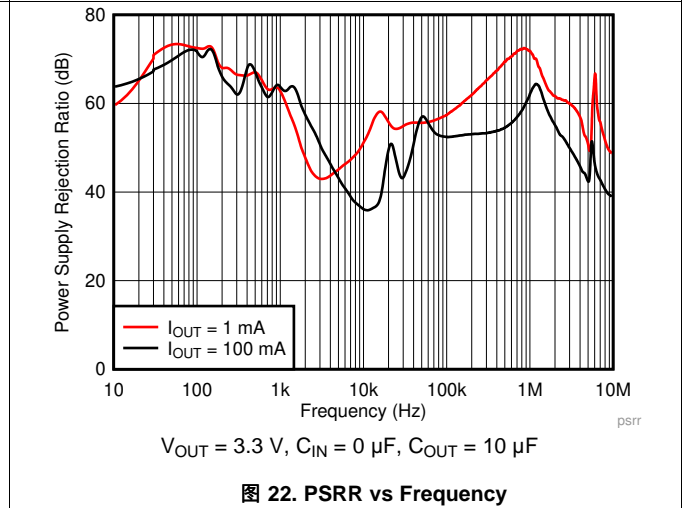

图 24. Output Capacitance vs ESR Stability

7 Detailed Description

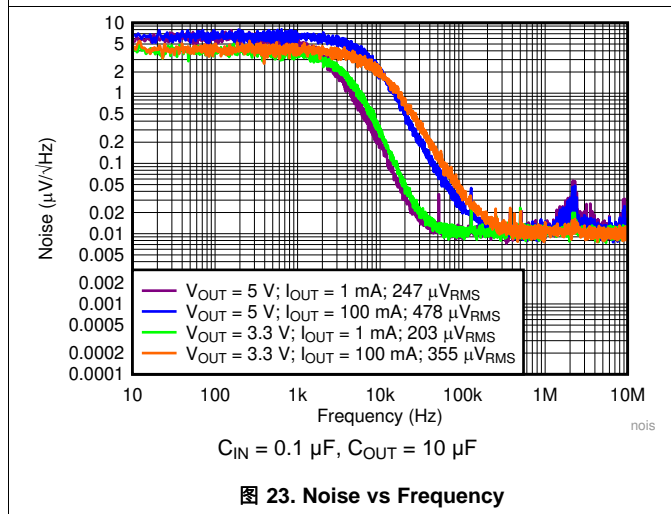
7.1 Overview

The TPS7B81-Q1 is a 40-V, 150-mA, low-dropout (LDO) linear regulator with ultralow quiescent current. This voltage regulator consumes only 3 μ A of quiescent current at light load, and is quite suitable for the automotive always-on application.

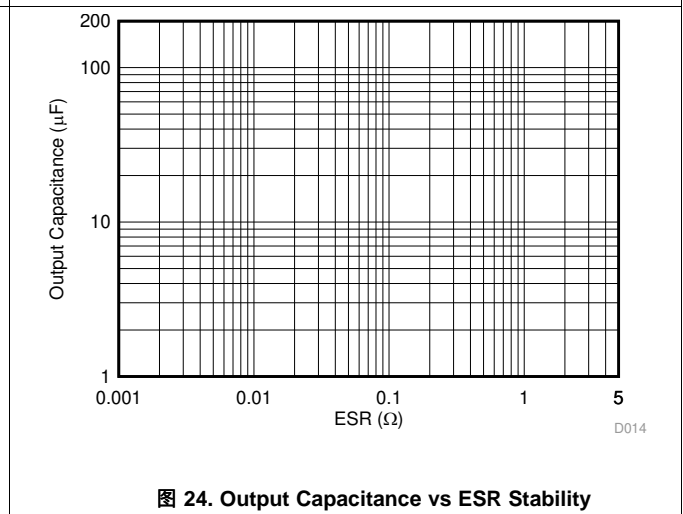
7.2 Functional Block Diagram

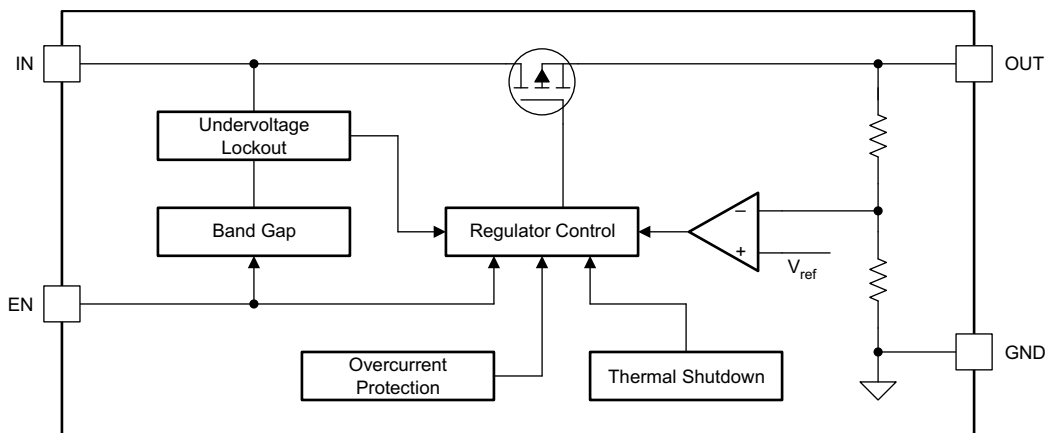

7.3 Feature Description

7.3.1 Device Enable (EN)

The EN pin is a high-voltage-tolerant pin. A high input activates the device and turns the regulation on. Connect this pin to an external microcontroller or a digital circuit to enable and disable the device, or connect to the IN pin for self-bias applications.

7.3.2 Undervoltage Shutdown

This device has an integrated undervoltage lockout (UVLO) circuit to shut down the output if the input voltage (V_{IN}) falls below an internal UVLO threshold ($V_{(UVLO)}$). This feature ensures that the regulator does not latch into an unknown state during low-input-voltage conditions. If the input voltage has a negative transient that drops below the UVLO threshold and recovers, the regulator shuts down and powers up with a normal power-up sequence when the input voltage is above the required level.

7.3.3 Current Limit

This device features current-limit protection to keep the device in a safe operating area when an overload or output short-to-ground condition occurs. This feature protects the device from excessive power dissipation. For example, during a short-circuit condition on the output, the fault protection limits the current through the pass element to $I_{(LIM)}$ to protect the device from excessive power dissipation.

7.3.4 Thermal Shutdown

This device incorporates a thermal shutdown (TSD) circuit as protection from overheating. For continuous normal operation, the junction temperature must not exceed the TSD trip point. If the junction temperature exceeds the TSD trip point, the output turns off. When the junction temperature falls below the TSD trip point minus the thermal shutdown hysteresis, the output turns on again.

7.4 Device Functional Modes

7.4.1 Operation With V_{IN} Lower Than 3 V

The device normally operates with input voltages above 3 V. The device can also operate at lower input voltages; the maximum UVLO voltage is 2.7 V. The device does not operate at input voltages below the actual UVLO voltage.

7.4.2 Operation With V_{IN} Larger Than 3 V

When V_{IN} is greater than 3 V, if V_{IN} is also higher than the output set value plus the device dropout voltage, V_{OUT} is equal to the set value. Otherwise, V_{OUT} is equal to V_{IN} minus the dropout voltage.

表 1. Device Functional Mode Comparison

OPERATING MODE	PARAMETER			
Normal mode	$V_{IN} > V_{OUT(nom)} + V_{(Dropout)}$ and $V_{IN} \geq 3\text{ V}$	$V_{EN} > V_{IH}$	$I_{OUT} < I_{CL}$	$T_J < 160^\circ\text{C}$
Dropout mode	$3\text{ V} \leq V_{IN} < V_{OUT(nom)} + V_{(Dropout)}$	$V_{EN} > V_{IH}$	$I_{OUT} < I_{CL}$	$T_J < 160^\circ\text{C}$
Disabled mode (any true condition disables the device)	$V_{IN} < V_{(IN, UVLO)}$	$V_{EN} < V_{IL}$	—	$T_J > 160^\circ\text{C}$

8 Application and Implementation

注

Information in the following applications sections is not part of the TI component specification, and TI does not warrant its accuracy or completeness. TI's customers are responsible for determining suitability of components for their purposes. Customers should validate and test their design implementation to confirm system functionality.

8.1 Application Information

The TPS7B81-Q1 is a 150-mA, 40-V, low-dropout (LDO) linear regulator with ultralow quiescent current. The PSpice transient model is available for download on the product folder and can be used to evaluate the basic function of the device.

8.1.1 Power Dissipation

Circuit reliability demands that proper consideration is given to device power dissipation, location of the circuit on the printed circuit board (PCB), and correct sizing of the thermal plane. The PCB area around the regulator must be as free as possible of other heat-generating devices that cause added thermal stresses.

As a first-order approximation, power dissipation in the regulator depends on the input-to-output voltage difference and load conditions. P_D can be approximated using [公式 1](#):

$$P_D = (V_{IN} - V_{OUT}) \times I_{OUT} \quad (1)$$

An important note is that power dissipation can be minimized, and thus greater efficiency achieved, by proper selection of the system voltage rails. Proper selection allows the minimum input-to-output voltage differential to be obtained. The low dropout of the device allows for maximum efficiency across a wide range of output voltages.

The main heat conduction path for the device is through the thermal pad on the package. As such, the thermal pad must be soldered to a copper pad area under the device. This pad area contains an array of plated vias that conduct heat to any inner plane areas or to a bottom-side copper plane.

The maximum power dissipation determines the maximum allowable junction temperature (T_J) for the device. Power dissipation and junction temperature are most often related by the junction-to-ambient thermal resistance ($R_{\theta JA}$) of the combined PCB, device package, and the temperature of the ambient air (T_A), according to [公式 2](#). The equation is rearranged for output current in [公式 3](#).

$$T_J = T_A + R_{\theta JA} \times P_D \quad (2)$$

$$I_{OUT} = (T_J - T_A) / [R_{\theta JA} \times (V_{IN} - V_{OUT})] \quad (3)$$

Unfortunately, this thermal resistance ($R_{\theta JA}$) is highly dependent on the heat-spreading capability built into the particular PCB design, and therefore varies according to the total copper area, copper weight, and location of the planes. The $R_{\theta JA}$ recorded in the [v](#) table is determined by the JEDEC standard, PCB, and copper-spreading area, and is only used as a relative measure of package thermal performance. Note that for a well-designed thermal layout, $R_{\theta JA}$ is actually the sum of the package junction-to-case (bottom) thermal resistance ($R_{\theta JCbot}$) plus the thermal resistance contribution by the PCB copper.

[图 25](#) through [图 30](#) show the functions of $R_{\theta JA}$ and ψ_{JB} vs. copper area and thickness. These plots are generated with a 101.6 mm x 101.6 mm x 1.6mm PCB of two and four layers. For the four layer board, inner planes use 1 oz copper thickness. Outer layers are simulated with both 1 oz and 2 oz copper thickness. A 2 x 1 array of thermal vias of 300 μ m drill diameter and 25 μ m Cu plating is located beneath the thermal pad of the device. The thermal vias connect the top layer, the bottom layer and, in the case of the 4-layer board, the first inner GND plane. Each of the layers has a copper plane of equal area.

Application Information (接下页)



图 25. $R_{\theta JA}$ versus Cu Area for the WSON (DRV) Package



图 26. ψ_{JB} versus Cu Area for the WSON (DRV) Package

Application Information (接下页)

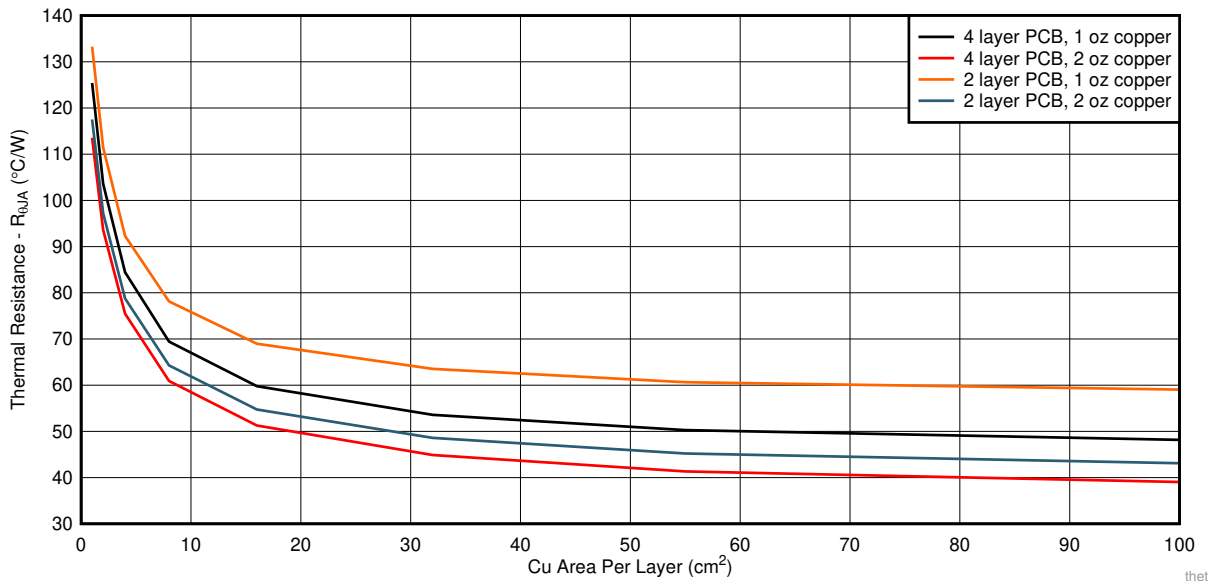

图 27. $R_{\theta JA}$ versus Cu Area for the HVSSOP (DGN) Package

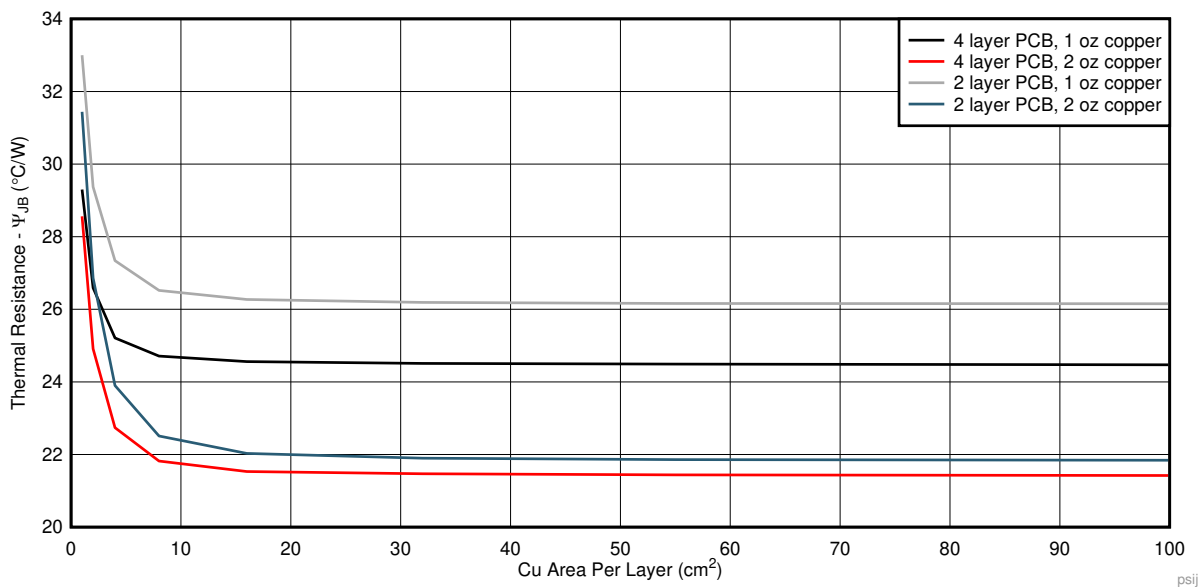

图 28. ψ_{JB} versus Cu Area for the HVSSOP (DGN) Package

Application Information (接下页)

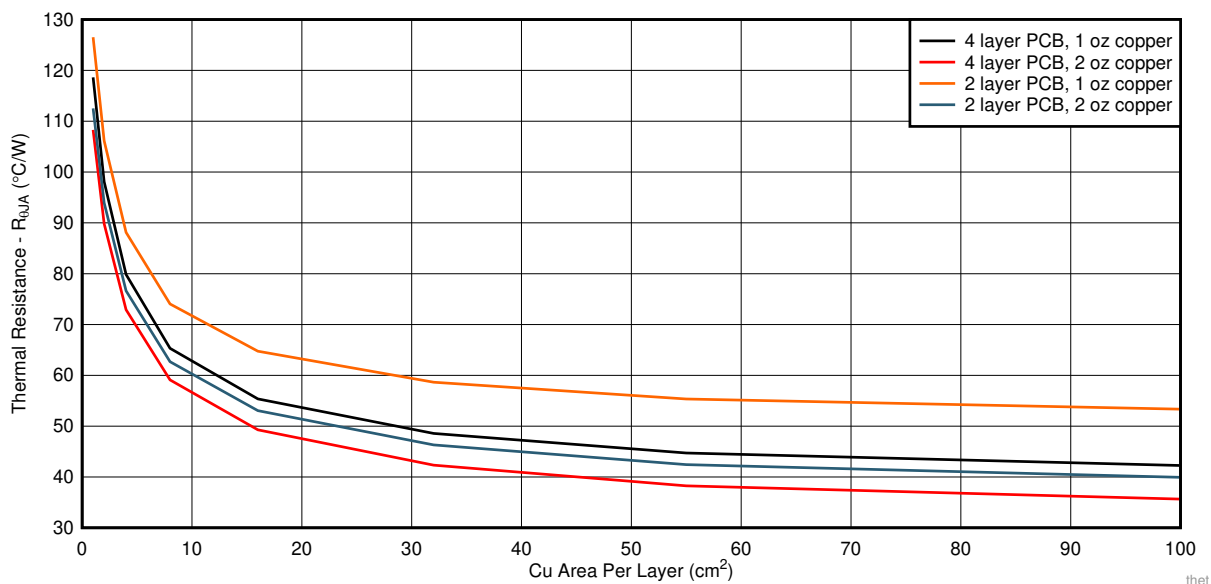

图 29. $R_{\theta JA}$ versus Cu Area for the TO-252 (KVU) Package

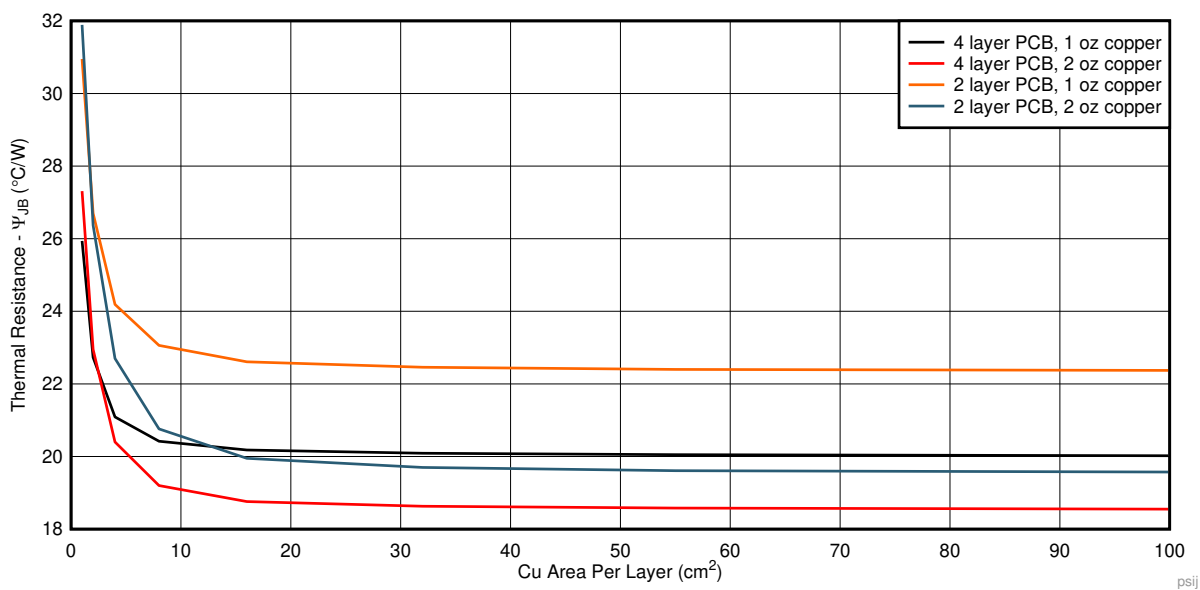

图 30. ψ_{JB} versus Cu Area for the TO-252 (KVU) Package

Application Information (接下页)

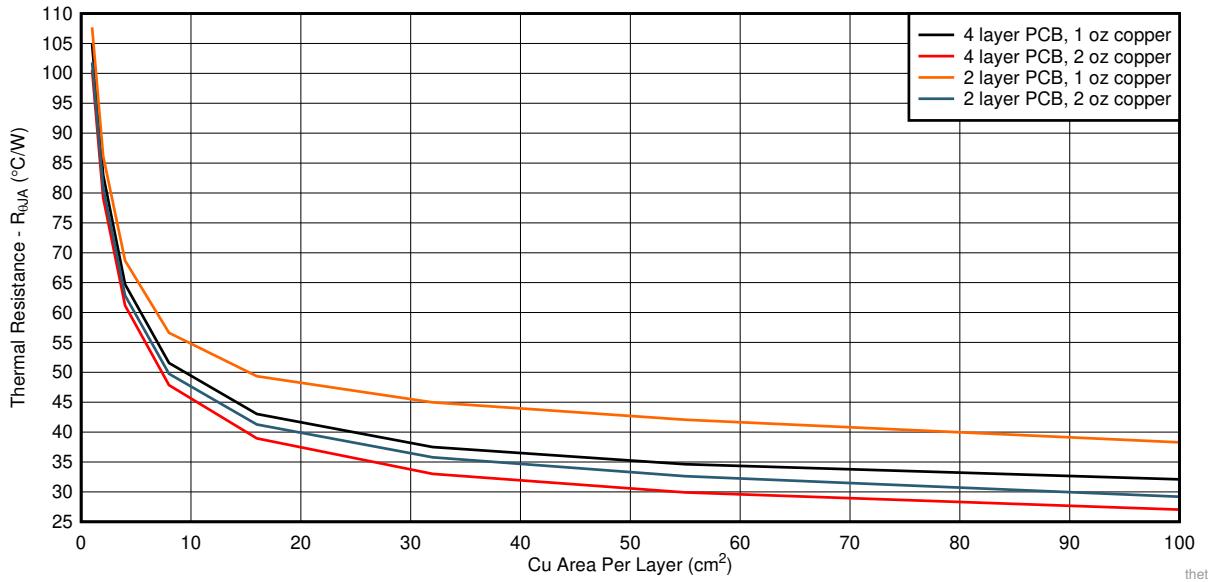
8.1.1.1 Estimating Junction Temperature

The JEDEC standard now recommends the use of psi (Ψ) thermal metrics to estimate the junction temperatures of the LDO when in-circuit on a typical PCB board application. These metrics are not strictly speaking thermal resistances, but rather offer practical and relative means of estimating junction temperatures. These psi metrics are determined to be significantly independent of the copper-spreading area. The key thermal metrics (Ψ_{JT} and Ψ_{JB}) are given in the [Thermal Information](#) table and are used in accordance with [公式 4](#).

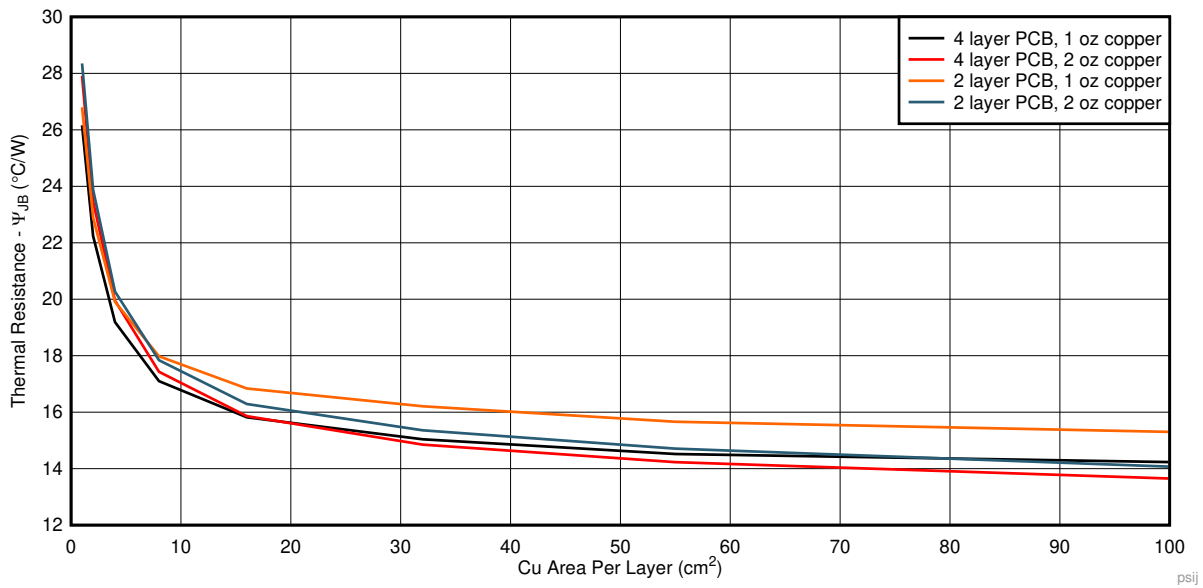
$$\Psi_{JT}: T_J = T_T + \Psi_{JT} \times P_D$$

$$\Psi_{JB}: T_J = T_B + \Psi_{JB} \times P_D$$

where:

- P_D is the power dissipated as explained in [公式 1](#)
 - T_T is the temperature at the center-top of the device package, and
 - T_B is the PCB surface temperature measured 1 mm from the device package and centered on the package edge
- (4)

8.2 Typical Application

[图 31](#) shows a typical application circuit for the TPS7B81-Q1. Different external component values can be used, depending on the end application. An application may require a larger output capacitor during fast load steps to prevent a large drop on the output voltage. TI recommends using a low-equivalent series resistance (ESR) ceramic capacitor with an X5R- or X7R-type dielectric.



图 31. TPS7B81-Q1 Typical Application Schematic

8.2.1 Design Requirements

Use the parameters listed in [表 2](#) for this design example.

表 2. Design Requirements Parameters

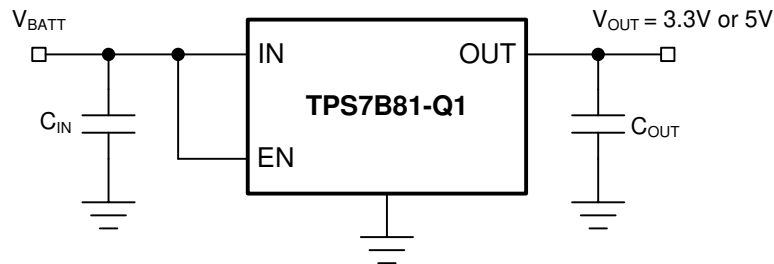
PARAMETER	VALUE
Input voltage range	3 V to 40 V
Output voltage	5 V or 3.3 V
Output current	150 mA maximum

8.2.2 Detailed Design Procedure

To begin the design process, determine the following:

- Input voltage range
- Output voltage
- Output current

8.2.2.1 Input Capacitor

Although an input capacitor is not required for stability, good analog design practice is to connect a 10- μ F to 22- μ F capacitor from IN to GND. This capacitor counteracts reactive input sources and improves transient response, input ripple rejection, and PSRR. The voltage rating must be greater than the maximum input voltage.

8.2.2.2 Output Capacitor

To ensure the stability of the TPS7B81-Q1, the device requires an output capacitor with a value in the range from 1 μF to 200 μF and with an ESR range between 0.001 Ω and 5 Ω . TI recommends selecting a ceramic capacitor with low ESR to improve the load transient response.

8.2.3 Application Curve



图 32. TPS7B81-Q1 Power-Up Waveform (5 V)

9 Power Supply Recommendations

The device is designed to operate from an input-voltage supply range from 3 V to 40 V. The input supply must be well regulated. If the input supply is located more than a few inches from the TPS7B81-Q1, TI recommends adding a capacitor with a value greater than or equal to 10 μF with a 0.1- μF bypass capacitor in parallel at the input.

10 Layout

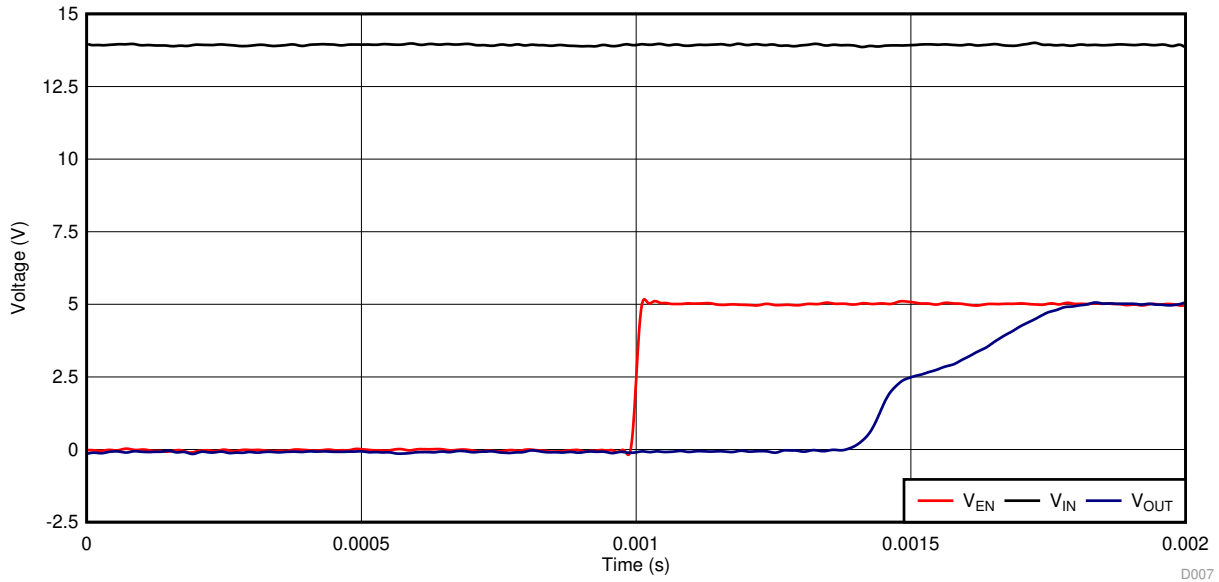
10.1 Layout Guidelines

Layout is an important step for LDO power supplies, especially for high-voltage and large-output-current supplies. If the layout is not carefully designed, the regulator can fail to deliver enough output current because of thermal limitations. To improve the thermal performance of the device, and to maximize the current output at high ambient temperature, spread the copper under the thermal pad as far as possible and put enough thermal vias on the copper under the thermal pad. 图 33 shows an example layout.

10.2 Layout Example



图 33. TPSB81-Q1 Example Layout Diagram

11 器件和文档支持

11.1 接收文档更新通知

要接收文档更新通知，请导航至 ti.com.cn 上的器件产品文件夹。单击右上角的通知我进行注册，即可每周接收产品信息更改摘要。有关更改的详细信息，请查看任何已修订文档中包含的修订历史记录。

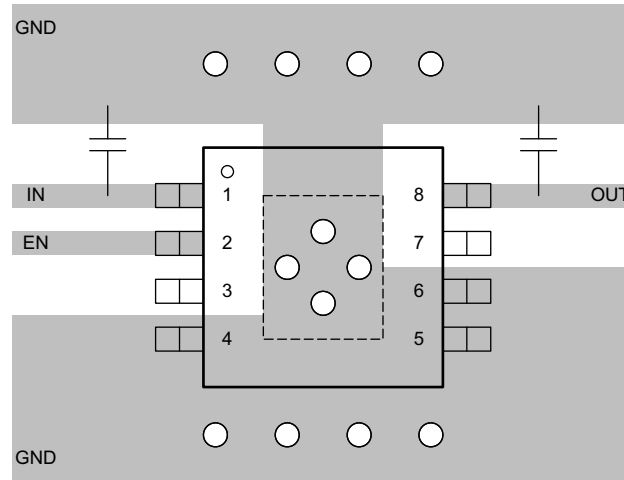
11.2 支持资源

[TI E2E™ support forums](#) are an engineer's go-to source for fast, verified answers and design help — straight from the experts. Search existing answers or ask your own question to get the quick design help you need.

Linked content is provided "AS IS" by the respective contributors. They do not constitute TI specifications and do not necessarily reflect TI's views; see TI's [Terms of Use](#).

11.3 商标

PowerPAD, E2E are trademarks of Texas Instruments.
All other trademarks are the property of their respective owners.

11.4 静电放电警告



ESD 可能会损坏该集成电路。德州仪器 (TI) 建议通过适当的预防措施处理所有集成电路。如果不遵守正确的处理措施和安装程序，可能会损坏集成电路。

ESD 的损坏小至导致微小的性能降级，大至整个器件故障。精密的集成电路可能更容易受到损坏，这是因为非常细微的参数更改都可能会导致器件与其发布的规格不相符。

11.5 Glossary

[SLYZ022](#) — *TI Glossary*.

This glossary lists and explains terms, acronyms, and definitions.

12 机械、封装和可订购信息

以下页面包含机械、封装和可订购信息。这些信息是指定器件的最新可用数据。数据如有变更，恕不另行通知，且不会对此文档进行修订。如需获取此数据表的浏览器版本，请查阅左侧的导航栏。

PACKAGING INFORMATION

Orderable part number	Status (1)	Material type (2)	Package Pins	Package qty Carrier	RoHS (3)	Lead finish/ Ball material (4)	MSL rating/ Peak reflow (5)	Op temp (°C)	Part marking (6)
TPS7B8125QDGNRQ1	Active	Production	HVSSOP (DGN) 8	2500 LARGE T&R	Yes	NIPDAUAG	Level-2-260C-1 YEAR	-40 to 150	26GX
TPS7B8125QDGNRQ1.A	Active	Production	HVSSOP (DGN) 8	2500 LARGE T&R	Yes	NIPDAUAG	Level-2-260C-1 YEAR	-40 to 150	26GX
TPS7B8133QDGNRQ1	Active	Production	HVSSOP (DGN) 8	2500 LARGE T&R	Yes	NIPDAUAG	Level-2-260C-1 YEAR	-40 to 150	1VTX
TPS7B8133QDGNRQ1.A	Active	Production	HVSSOP (DGN) 8	2500 LARGE T&R	Yes	NIPDAUAG	Level-2-260C-1 YEAR	-40 to 150	1VTX
TPS7B8133QDRVRQ1	Active	Production	WSON (DRV) 6	3000 LARGE T&R	Yes	NIPDAU	Level-2-260C-1 YEAR	-40 to 150	1X2H
TPS7B8133QDRVRQ1.A	Active	Production	WSON (DRV) 6	3000 LARGE T&R	Yes	NIPDAU	Level-2-260C-1 YEAR	-40 to 150	1X2H
TPS7B8133QKVURQ1	Active	Production	TO-252 (KVU) 5	2500 LARGE T&R	Yes	SN	Level-3-260C-168 HR	-40 to 150	7B8133Q1
TPS7B8133QKVURQ1.A	Active	Production	TO-252 (KVU) 5	2500 LARGE T&R	Yes	SN	Level-3-260C-168 HR	-40 to 150	7B8133Q1
TPS7B8150QDGNRQ1	Active	Production	HVSSOP (DGN) 8	2500 LARGE T&R	Yes	NIPDAUAG	Level-2-260C-1 YEAR	-40 to 150	1VUX
TPS7B8150QDGNRQ1.A	Active	Production	HVSSOP (DGN) 8	2500 LARGE T&R	Yes	NIPDAUAG	Level-2-260C-1 YEAR	-40 to 150	1VUX
TPS7B8150QDRVRQ1	Active	Production	WSON (DRV) 6	3000 LARGE T&R	Yes	NIPDAU	Level-2-260C-1 YEAR	-40 to 150	1WNH
TPS7B8150QDRVRQ1.A	Active	Production	WSON (DRV) 6	3000 LARGE T&R	Yes	NIPDAU	Level-2-260C-1 YEAR	-40 to 150	1WNH
TPS7B8150QKVURQ1	Active	Production	TO-252 (KVU) 5	2500 LARGE T&R	Yes	SN	Level-3-260C-168 HR	-40 to 150	7B8150Q1
TPS7B8150QKVURQ1.A	Active	Production	TO-252 (KVU) 5	2500 LARGE T&R	Yes	SN	Level-3-260C-168 HR	-40 to 150	7B8150Q1

(1) **Status:** For more details on status, see our [product life cycle](#).

(2) **Material type:** When designated, preproduction parts are prototypes/experimental devices, and are not yet approved or released for full production. Testing and final process, including without limitation quality assurance, reliability performance testing, and/or process qualification, may not yet be complete, and this item is subject to further changes or possible discontinuation. If available for ordering, purchases will be subject to an additional waiver at checkout, and are intended for early internal evaluation purposes only. These items are sold without warranties of any kind.

(3) **RoHS values:** Yes, No, RoHS Exempt. See the [TI RoHS Statement](#) for additional information and value definition.

(4) **Lead finish/Ball material:** Parts may have multiple material finish options. Finish options are separated by a vertical ruled line. Lead finish/Ball material values may wrap to two lines if the finish value exceeds the maximum column width.

(5) **MSL rating/Peak reflow:** The moisture sensitivity level ratings and peak solder (reflow) temperatures. In the event that a part has multiple moisture sensitivity ratings, only the lowest level per JEDEC standards is shown. Refer to the shipping label for the actual reflow temperature that will be used to mount the part to the printed circuit board.

(6) **Part marking:** There may be an additional marking, which relates to the logo, the lot trace code information, or the environmental category of the part.

Multiple part markings will be inside parentheses. Only one part marking contained in parentheses and separated by a "~" will appear on a part. If a line is indented then it is a continuation of the previous line and the two combined represent the entire part marking for that device.

Important Information and Disclaimer: The information provided on this page represents TI's knowledge and belief as of the date that it is provided. TI bases its knowledge and belief on information provided by third parties, and makes no representation or warranty as to the accuracy of such information. Efforts are underway to better integrate information from third parties. TI has taken and continues to take reasonable steps to provide representative and accurate information but may not have conducted destructive testing or chemical analysis on incoming materials and chemicals. TI and TI suppliers consider certain information to be proprietary, and thus CAS numbers and other limited information may not be available for release.

In no event shall TI's liability arising out of such information exceed the total purchase price of the TI part(s) at issue in this document sold by TI to Customer on an annual basis.

OTHER QUALIFIED VERSIONS OF TPS7B81-Q1 :

- Catalog : [TPS7B81](#)

NOTE: Qualified Version Definitions:

- Catalog - TI's standard catalog product

TAPE AND REEL INFORMATION

QUADRANT ASSIGNMENTS FOR PIN 1 ORIENTATION IN TAPE

*All dimensions are nominal

Device	Package Type	Package Drawing	Pins	SPQ	Reel Diameter (mm)	Reel Width W1 (mm)	A0 (mm)	B0 (mm)	K0 (mm)	P1 (mm)	W (mm)	Pin1 Quadrant
TPS7B8125QDGNRQ1	HVSSOP	DGN	8	2500	330.0	12.4	5.3	3.4	1.4	8.0	12.0	Q1
TPS7B8133QDGNRQ1	HVSSOP	DGN	8	2500	330.0	12.4	5.3	3.4	1.4	8.0	12.0	Q1
TPS7B8133QDRVRQ1	WSOP	DRV	6	3000	180.0	8.4	2.3	2.3	1.15	4.0	8.0	Q2
TPS7B8133QKVURQ1	TO-252	KVU	5	2500	330.0	16.4	6.9	10.5	2.7	8.0	16.0	Q2
TPS7B8150QDGNRQ1	HVSSOP	DGN	8	2500	330.0	12.4	5.3	3.4	1.4	8.0	12.0	Q1
TPS7B8150QDRVRQ1	WSOP	DRV	6	3000	180.0	8.4	2.3	2.3	1.15	4.0	8.0	Q2
TPS7B8150QKVURQ1	TO-252	KVU	5	2500	330.0	16.4	6.9	10.5	2.7	8.0	16.0	Q2

TAPE AND REEL BOX DIMENSIONS



*All dimensions are nominal

Device	Package Type	Package Drawing	Pins	SPQ	Length (mm)	Width (mm)	Height (mm)
TPS7B8125QDGNRQ1	HVSSOP	DGN	8	2500	366.0	364.0	50.0
TPS7B8133QDGNRQ1	HVSSOP	DGN	8	2500	366.0	364.0	50.0
TPS7B8133QDRVRQ1	WSON	DRV	6	3000	210.0	185.0	35.0
TPS7B8133QKVURQ1	TO-252	KVU	5	2500	340.0	340.0	38.0
TPS7B8150QDGNRQ1	HVSSOP	DGN	8	2500	366.0	364.0	50.0
TPS7B8150QDRVRQ1	WSON	DRV	6	3000	210.0	185.0	35.0
TPS7B8150QKVURQ1	TO-252	KVU	5	2500	340.0	340.0	38.0

GENERIC PACKAGE VIEW

DRV 6

WSON - 0.8 mm max height

PLASTIC SMALL OUTLINE - NO LEAD



Images above are just a representation of the package family, actual package may vary.
Refer to the product data sheet for package details.

4206925/F



4222173/B 04/2018

NOTES:

1. All linear dimensions are in millimeters. Any dimensions in parenthesis are for reference only. Dimensioning and tolerancing per ASME Y14.5M.
2. This drawing is subject to change without notice.
3. The package thermal pad must be soldered to the printed circuit board for thermal and mechanical performance.

EXAMPLE BOARD LAYOUT

DRV0006A

WSON - 0.8 mm max height

PLASTIC SMALL OUTLINE - NO LEAD



LAND PATTERN EXAMPLE
SCALE:25X



SOLDER MASK DETAILS

4222173/B 04/2018

NOTES: (continued)

4. This package is designed to be soldered to a thermal pad on the board. For more information, see Texas Instruments literature number SLUA271 (www.ti.com/lit/slue271).
5. Vias are optional depending on application, refer to device data sheet. If some or all are implemented, recommended via locations are shown.

EXAMPLE STENCIL DESIGN

DRV0006A

WSON - 0.8 mm max height

PLASTIC SMALL OUTLINE - NO LEAD



SOLDER PASTE EXAMPLE
BASED ON 0.125 mm THICK STENCIL

EXPOSED PAD #7
88% PRINTED SOLDER COVERAGE BY AREA UNDER PACKAGE
SCALE:30X

4222173/B 04/2018

NOTES: (continued)

6. Laser cutting apertures with trapezoidal walls and rounded corners may offer better paste release. IPC-7525 may have alternate design recommendations.

MECHANICAL DATA

KVU (R-PSFM-G5)

PLASTIC FLANGE-MOUNT PACKAGE

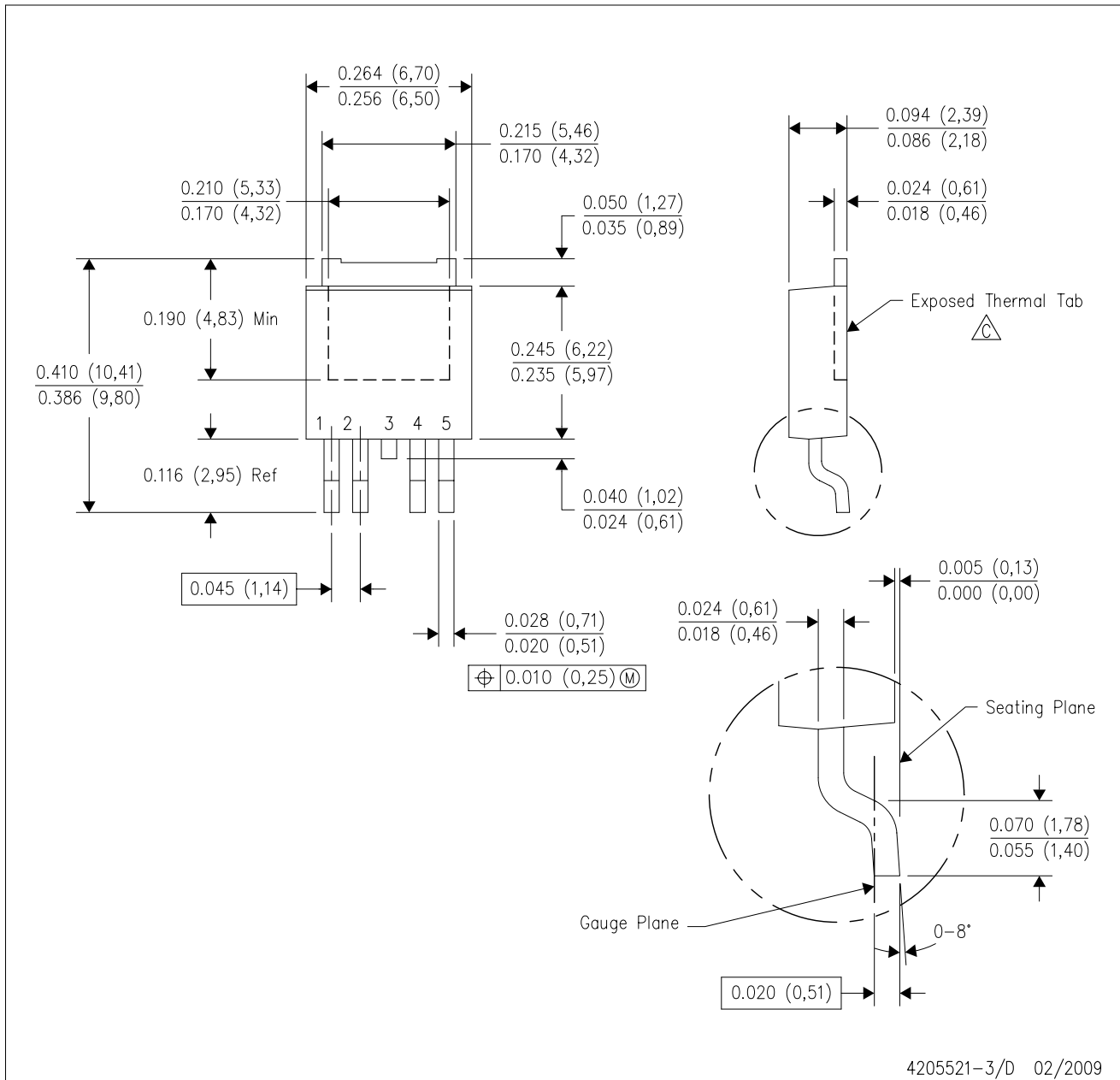

4205521-3/D 02/2009

- NOTES:
- A. All linear dimensions are in inches (millimeters).
 - B. This drawing is subject to change without notice.
 - △ The center lead is in electrical contact with the exposed thermal tab.
 - D. Body Dimensions do not include mold flash or protrusions. Mold flash and protrusion shall not exceed 0.006 (0,15) per side.
 - E. Falls within JEDEC TO-252 variation AD.

KVU (R-PSFM-G5)

PLASTIC FLANGE MOUNT PACKAGE

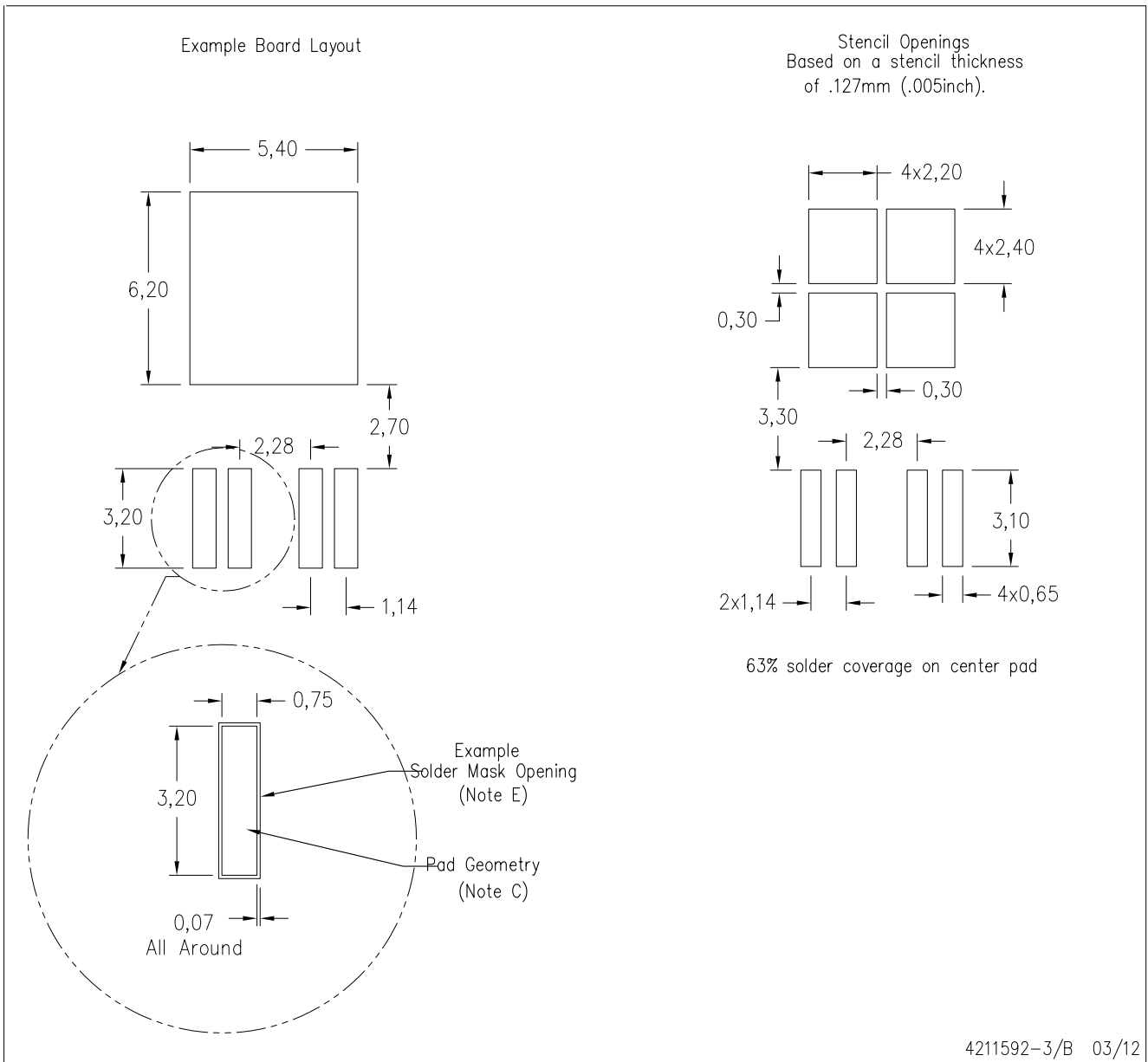

- NOTES:
- A. All linear dimensions are in millimeters.
 - B. This drawing is subject to change without notice.
 - C. Publication IPC-SM-782 is an alternate information source for PCB land pattern designs.
 - D. Laser cutting apertures with trapezoidal walls and also rounding corners will offer better paste release. Customers should contact their board assembly site for stencil design recommendations. Refer to IPC-7525 for other stencil recommendations.
 - E. Customers should contact their board fabrication site for recommended solder mask tolerances and via tenting recommendations for vias placed in thermal pad.

GENERIC PACKAGE VIEW

DGN 8

PowerPAD™ HVSSOP - 1.1 mm max height

3 x 3, 0.65 mm pitch

SMALL OUTLINE PACKAGE

This image is a representation of the package family, actual package may vary.
Refer to the product data sheet for package details.

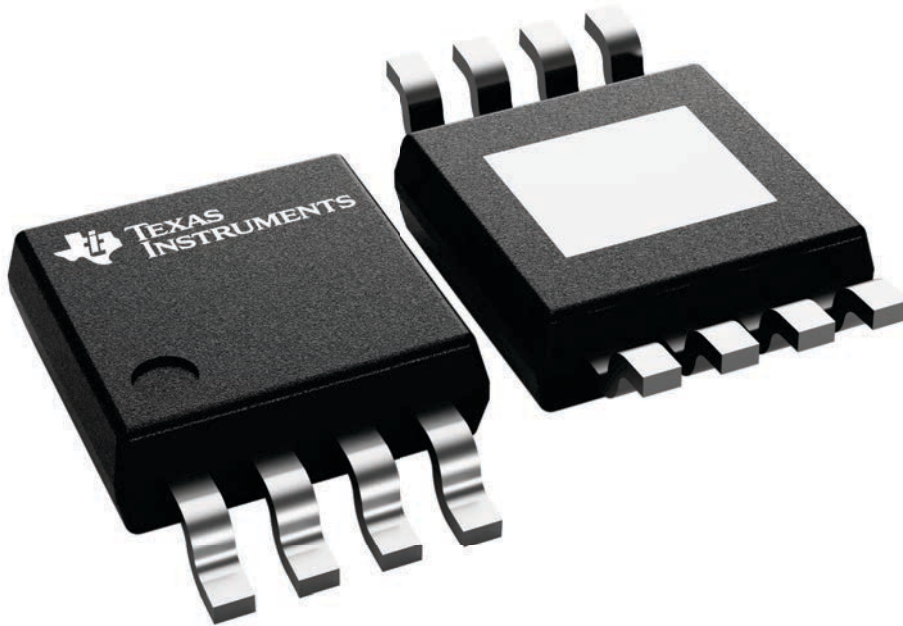

4225482/B

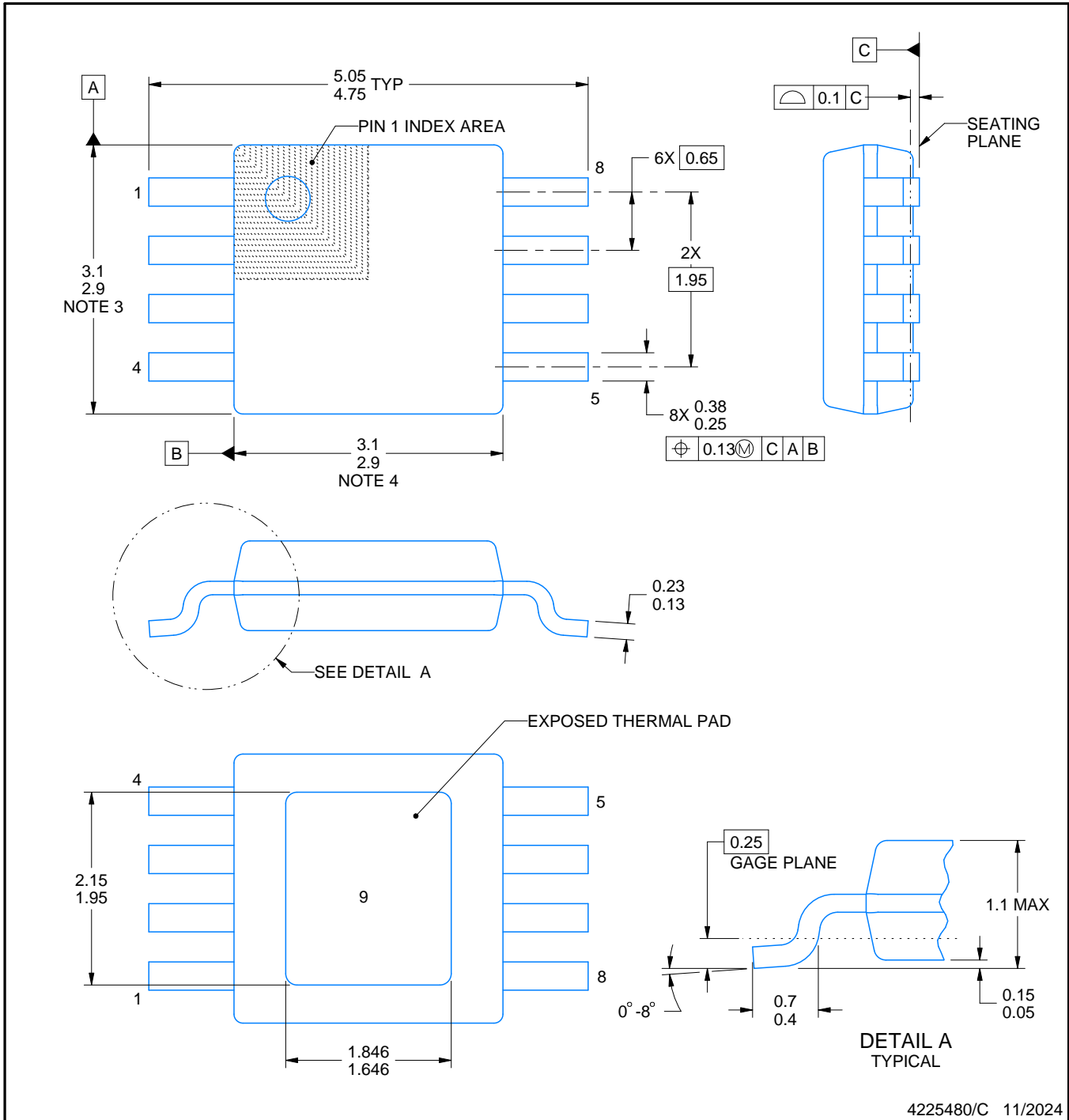
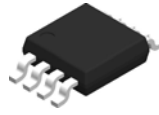

4225480/C 11/2024

PowerPAD is a trademark of Texas Instruments.

NOTES:

1. All linear dimensions are in millimeters. Any dimensions in parenthesis are for reference only. Dimensioning and tolerancing per ASME Y14.5M.
2. This drawing is subject to change without notice.
3. This dimension does not include mold flash, protrusions, or gate burrs. Mold flash, protrusions, or gate burrs shall not exceed 0.15 mm per side.
4. This dimension does not include interlead flash. Interlead flash shall not exceed 0.25 mm per side.
5. Reference JEDEC registration MO-187.

EXAMPLE BOARD LAYOUT

DGN0008G

PowerPAD™ HVSSOP - 1.1 mm max height

SMALL OUTLINE PACKAGE

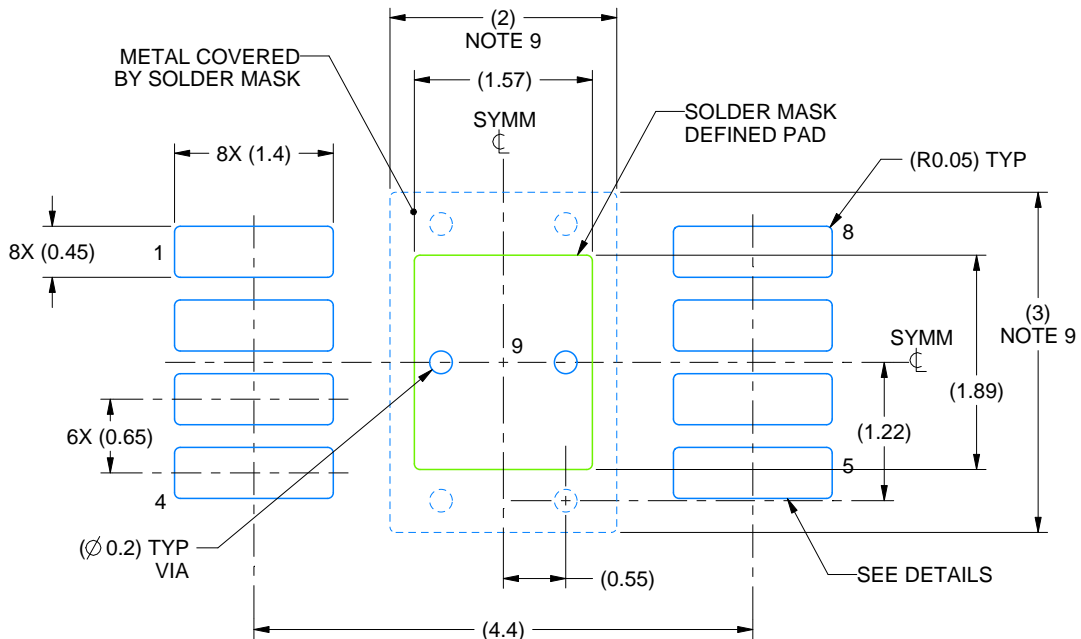

LAND PATTERN EXAMPLE
EXPOSED METAL SHOWN
SCALE: 15X

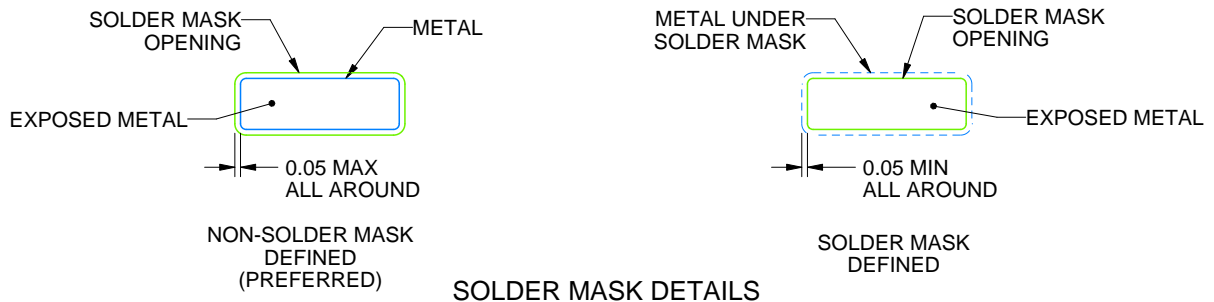

SOLDER MASK DETAILS

4225480/C 11/2024

NOTES: (continued)

6. Publication IPC-7351 may have alternate designs.
7. Solder mask tolerances between and around signal pads can vary based on board fabrication site.
8. Vias are optional depending on application, refer to device data sheet. If any vias are implemented, refer to their locations shown on this view. It is recommended that vias under paste be filled, plugged or tented.
9. Size of metal pad may vary due to creepage requirement.

EXAMPLE STENCIL DESIGN

DGN0008G

PowerPAD™ HVSSOP - 1.1 mm max height

SMALL OUTLINE PACKAGE

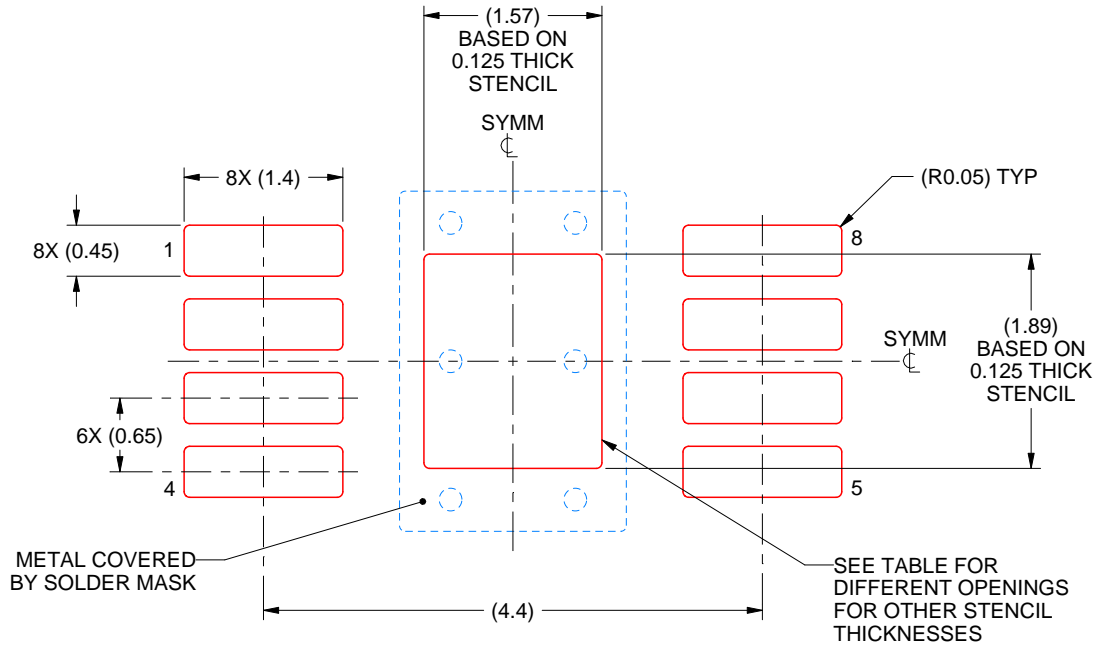

SOLDER PASTE EXAMPLE
EXPOSED PAD 9:
100% PRINTED SOLDER COVERAGE BY AREA
SCALE: 15X

STENCIL THICKNESS	SOLDER STENCIL OPENING
0.1	1.76 X 2.11
0.125	1.57 X 1.89 (SHOWN)
0.15	1.43 X 1.73
0.175	1.33 X 1.60

4225480/C 11/2024

NOTES: (continued)

10. Laser cutting apertures with trapezoidal walls and rounded corners may offer better paste release. IPC-7525 may have alternate design recommendations.
11. Board assembly site may have different recommendations for stencil design.

重要通知和免责声明

TI“按原样”提供技术和可靠性数据（包括数据表）、设计资源（包括参考设计）、应用或其他设计建议、网络工具、安全信息和其他资源，不保证没有瑕疵且不做任何明示或暗示的担保，包括但不限于对适销性、某特定用途方面的适用性或不侵犯任何第三方知识产权的暗示担保。

这些资源可供使用 TI 产品进行设计的熟练开发人员使用。您将自行承担以下全部责任：(1) 针对您的应用选择合适的 TI 产品，(2) 设计、验证并测试您的应用，(3) 确保您的应用满足相应标准以及任何其他功能安全、信息安全、监管或其他要求。

这些资源如有变更，恕不另行通知。TI 授权您仅可将这些资源用于研发本资源所述的 TI 产品的相关应用。严禁以其他方式对这些资源进行复制或展示。您无权使用任何其他 TI 知识产权或任何第三方知识产权。您应全额赔偿因在这些资源的使用中对 TI 及其代表造成的任何索赔、损害、成本、损失和债务，TI 对此概不负责。

TI 提供的产品受 [TI 的销售条款](#) 或 [ti.com](#) 上其他适用条款/TI 产品随附的其他适用条款的约束。TI 提供这些资源并不会扩展或以其他方式更改 TI 针对 TI 产品发布的适用的担保或担保免责声明。

TI 反对并拒绝您可能提出的任何其他或不同的条款。

邮寄地址：Texas Instruments, Post Office Box 655303, Dallas, Texas 75265
版权所有 © 2025，德州仪器 (TI) 公司